

Vorderansicht

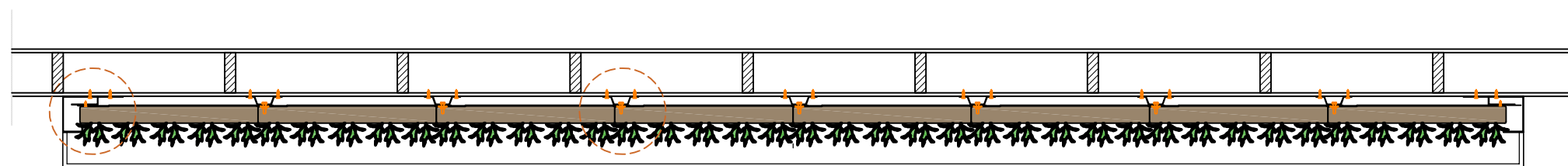

Querschnitt B-B

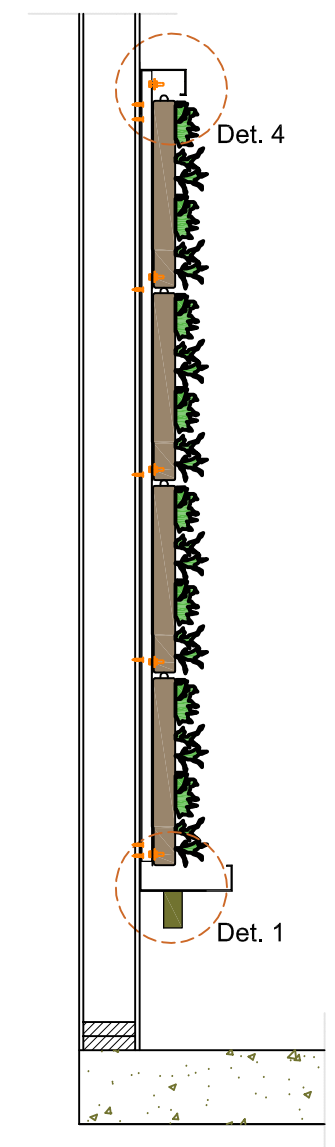

Querschnitt A-A

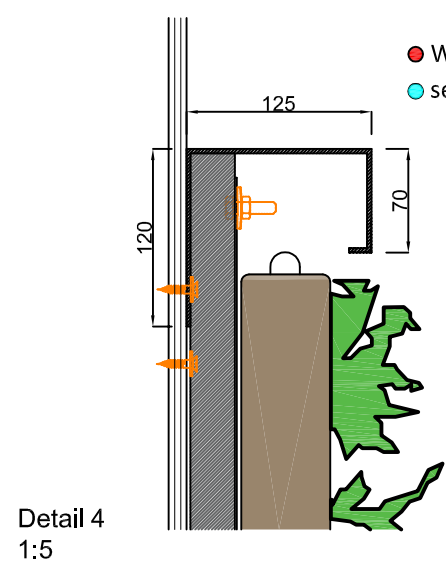
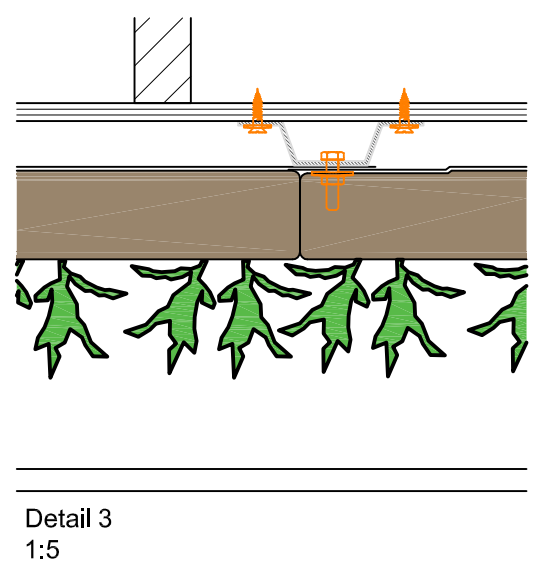
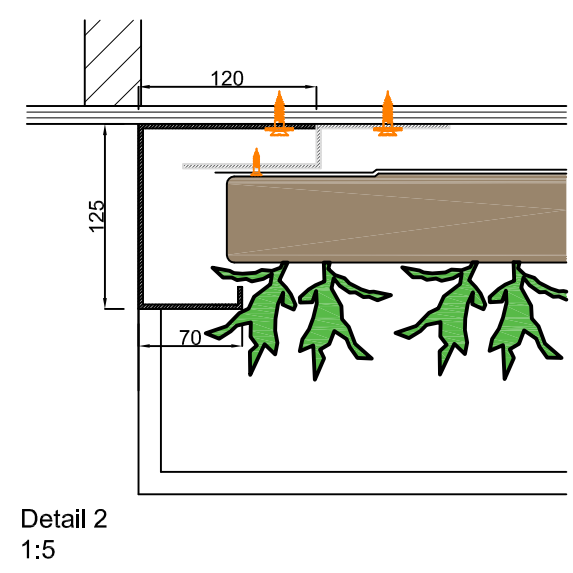
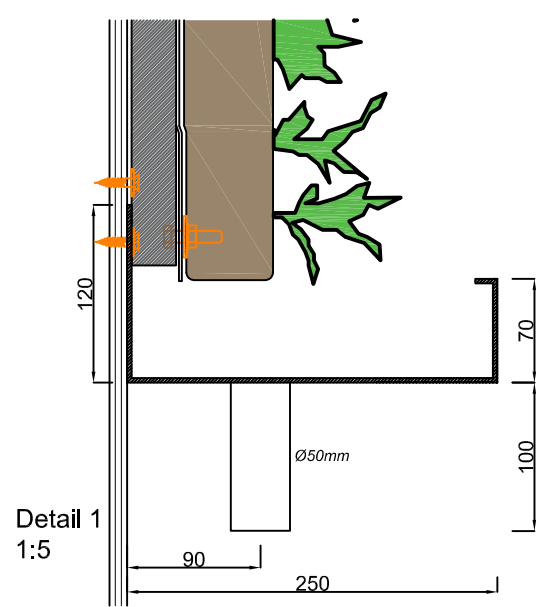

- Wasserleitung 3/4" Innengewinde DN15-32 Pex/Al/Pex
- sensor kabel Feuchtesensor Typ CY 2 x 0,5-1,0mm²

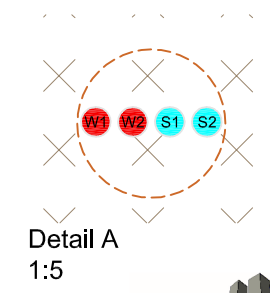

- Cradle to Cradle zertifiziert
- Max. gesättigtes Gewicht
- 45 kg/m²
- Webbasiertes Bewässerungssystem
- Pflanzenpflegesystem
- Garantie Flexipanel
- 10 Jahre

Beschreibung
SemperGreenwall Indoor

Maßstab
1:20 / 1:5

Format
A3

Datum
25.01.2021

Zeichnung Nr.
SGWI-H01

sempergreen wall
www.sempergreenwall.com

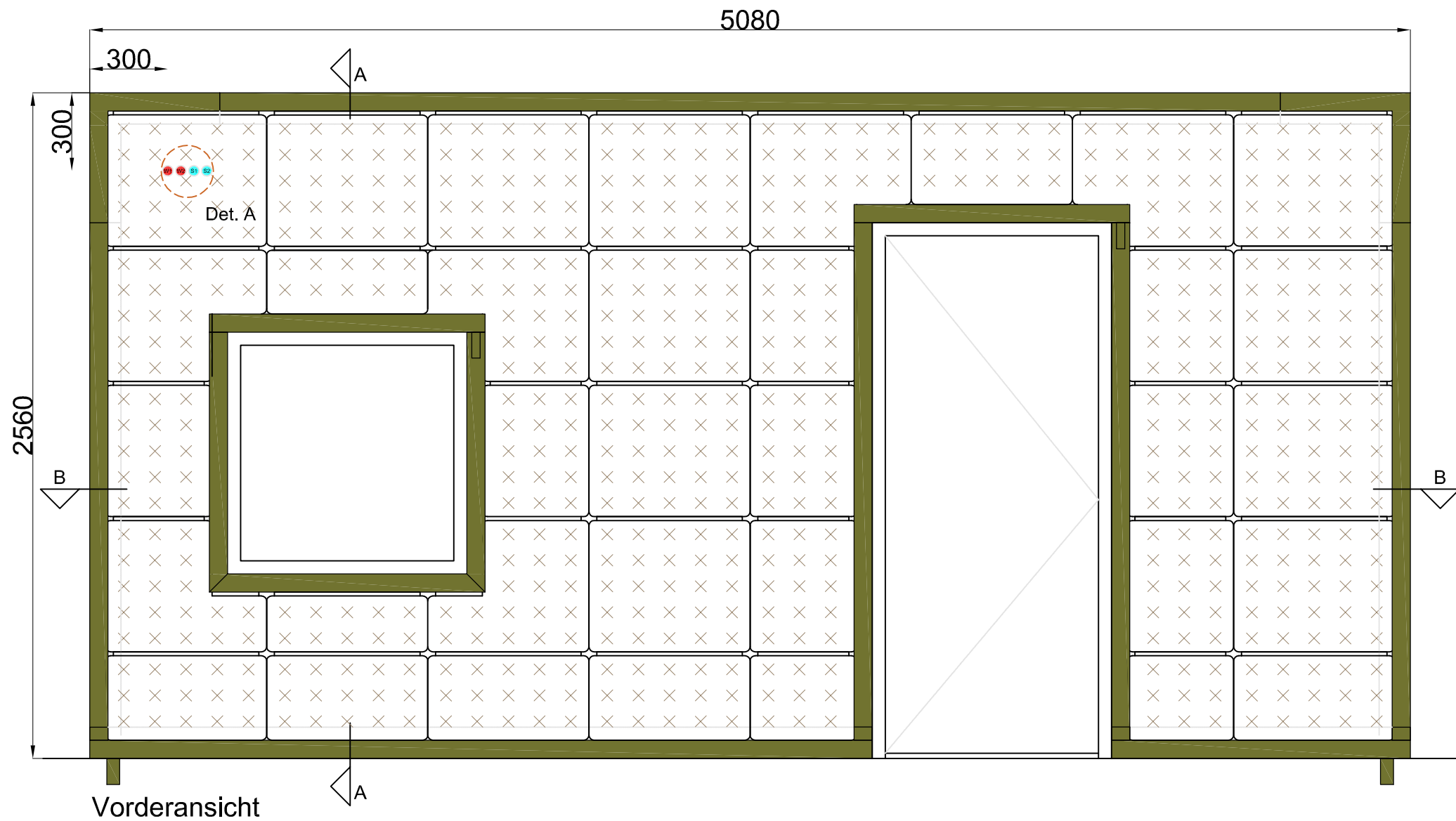

Vorderansicht

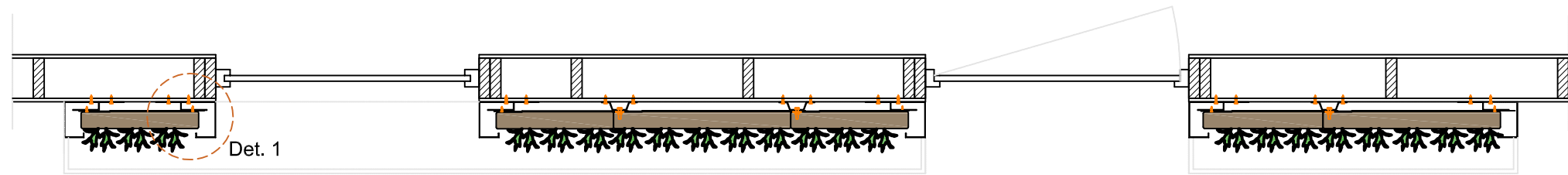

Querschnitt

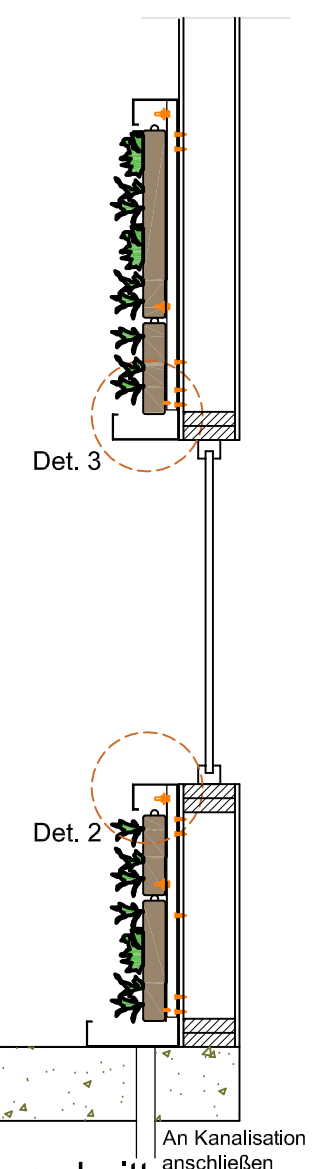

Querschnitt A-A

Cradle to Cradle
zertifiziert



Max. gesättigtes
Gewicht



Webbasiertes
Bewässerungssystem



Garantie Flexipanel

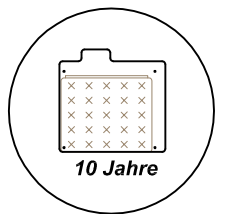

- Wasserleitung 3/4" Innengewinde DN15-32 Pex/Al/Pex
- sensorkabel Feuchtesensor Typ CY 2 x 0,5-1,0mm²

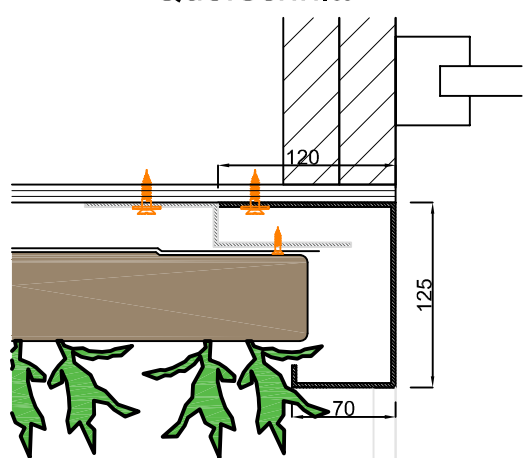

Detail 1
1:5

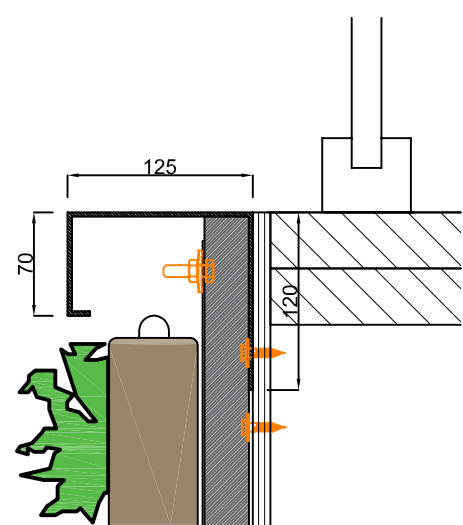

Detail 2
1:5

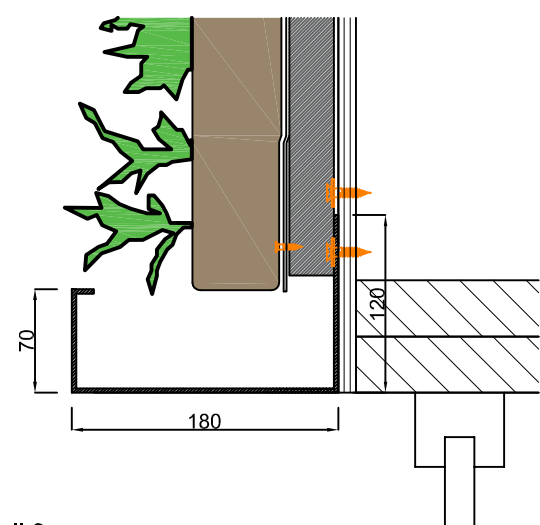

Detail 3
1:5

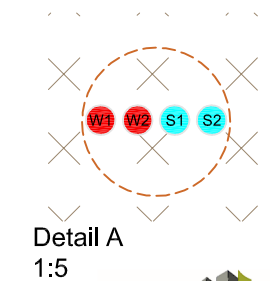

Detail A
1:5



www.sempergreenwall.com

Beschreibung
SemperGreenwall
Indoor Fenster- / Türdetails

Maßstab
1:20 / 1:5

Format
A3

Datum
25.01.2021

Zeichnung Nr.
SGWI-H02

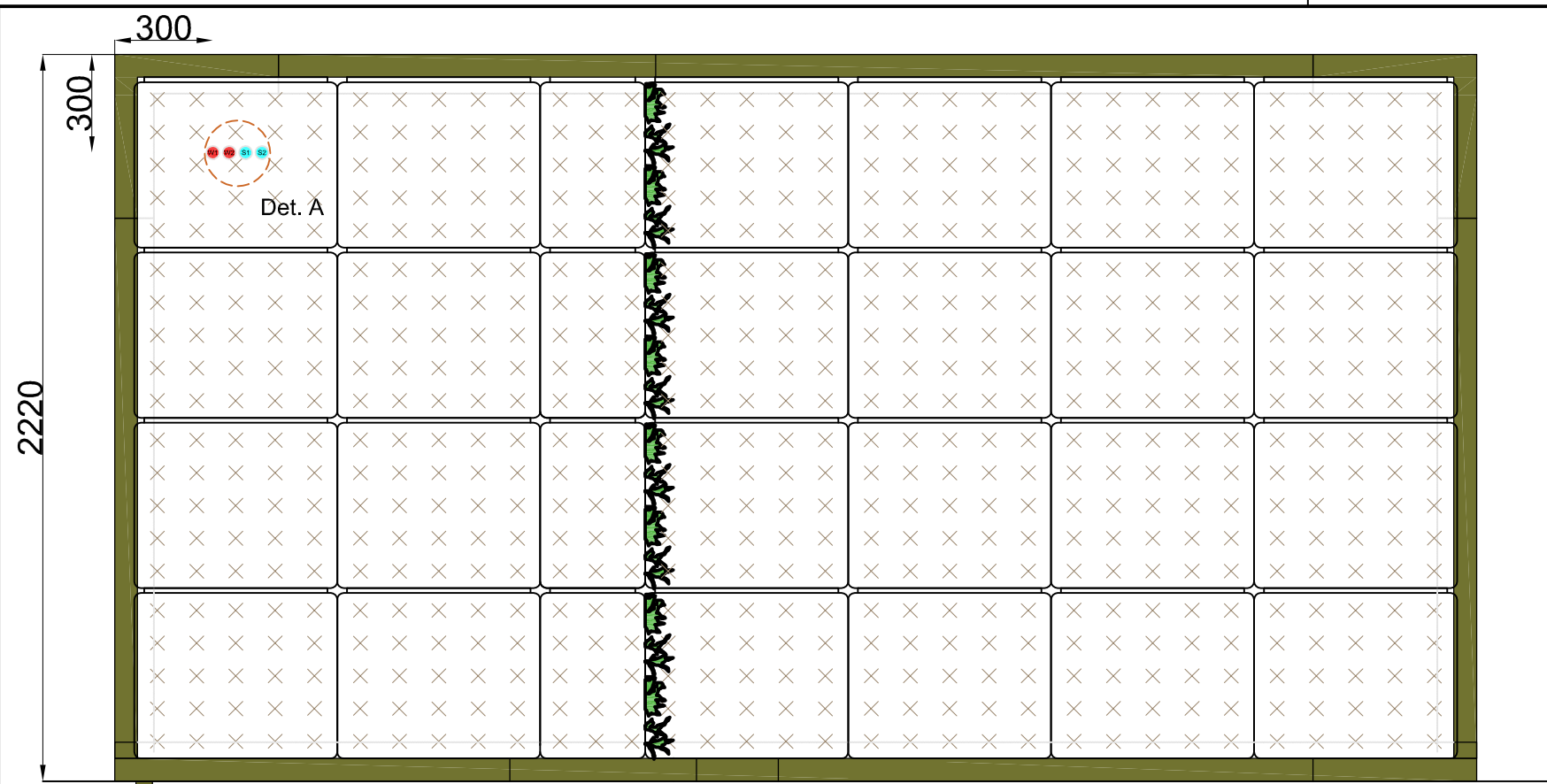

Ansicht A.

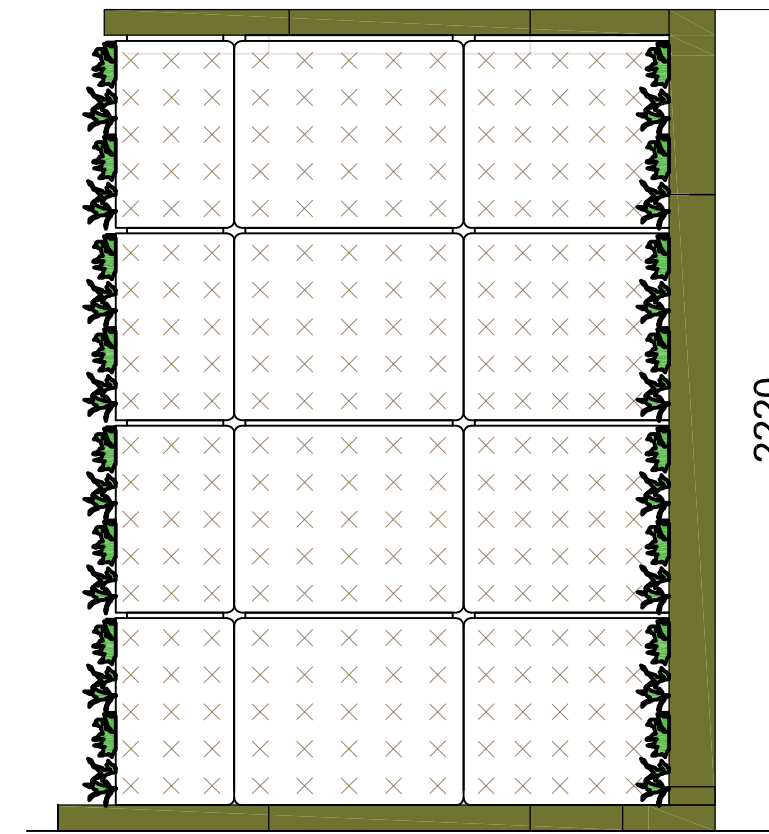

Ansicht B.

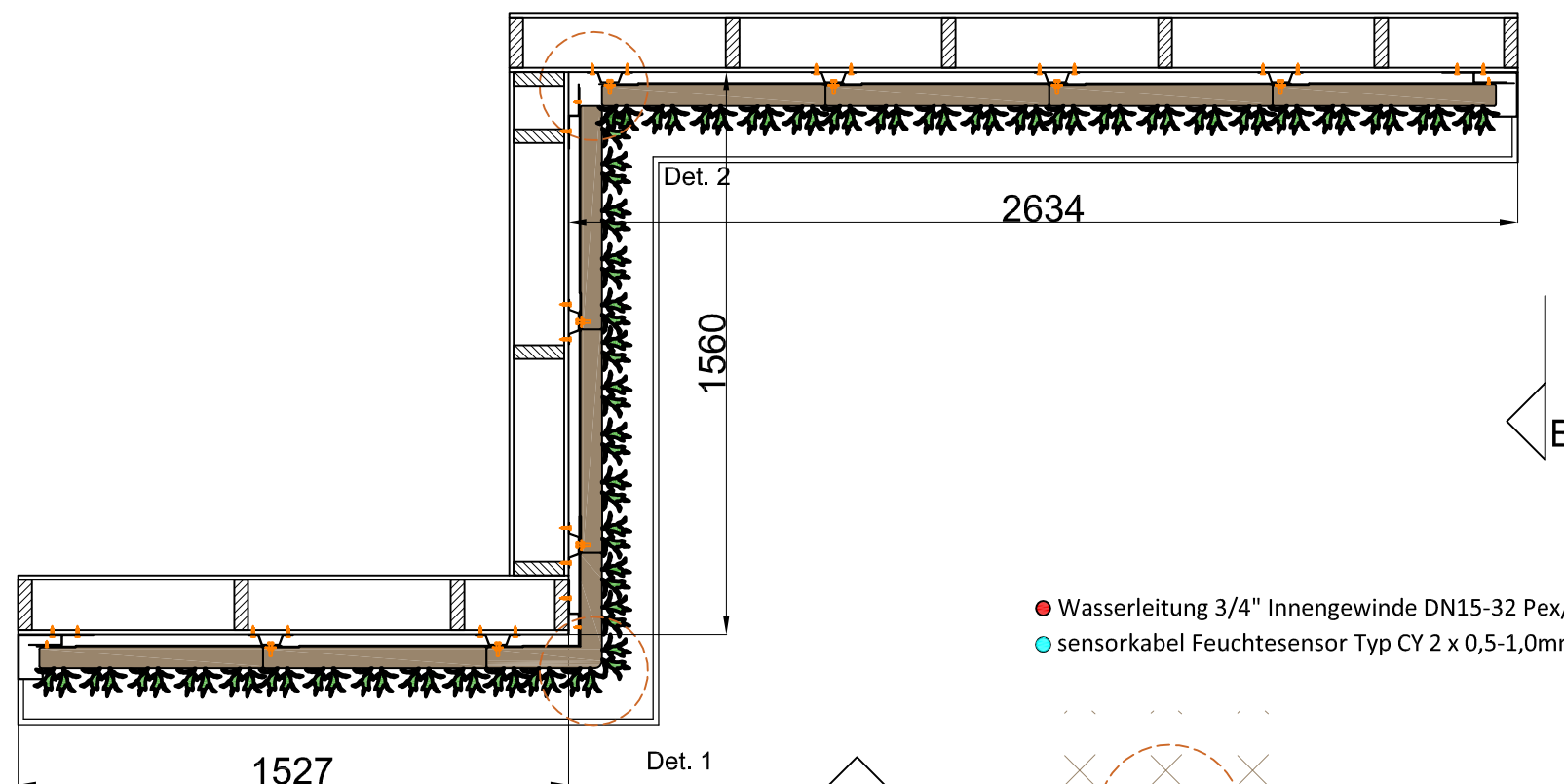

- Wasserleitung 3/4" Innengewinde DN15-32 Pex/Al/Pex
- sensor kabel Feuchtesensor Typ CY 2 x 0,5-1,0mm²

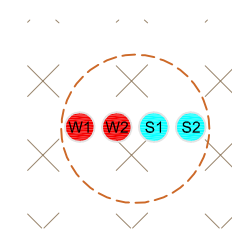

Detail A
1:8

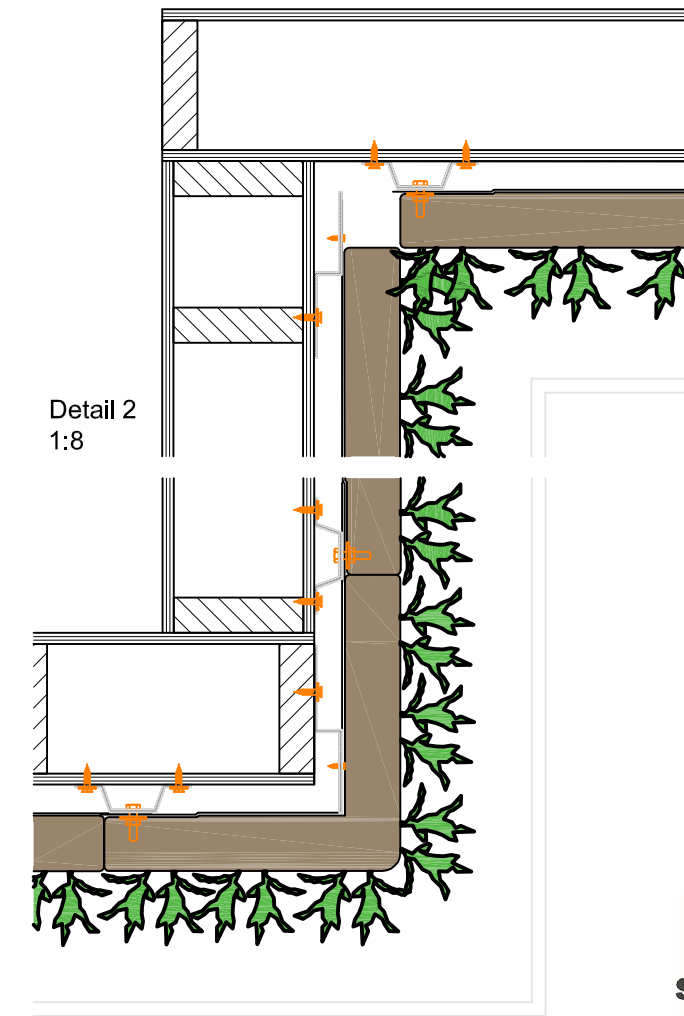

Detail 1
1:8

Cradle to Cradle
zertifiziert



Max. gesättigtes
Gewicht



Webbasiertes
Bewässerungssystem



Garantie Flexipanel

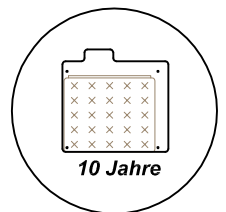

Beschreibung
SemperGreenwall
Indoor Eckdetails

Maßstab
1:20 / 1:8

Format
A3

Datum
25.01.2021

Zeichnung Nr.
SGWI-H03



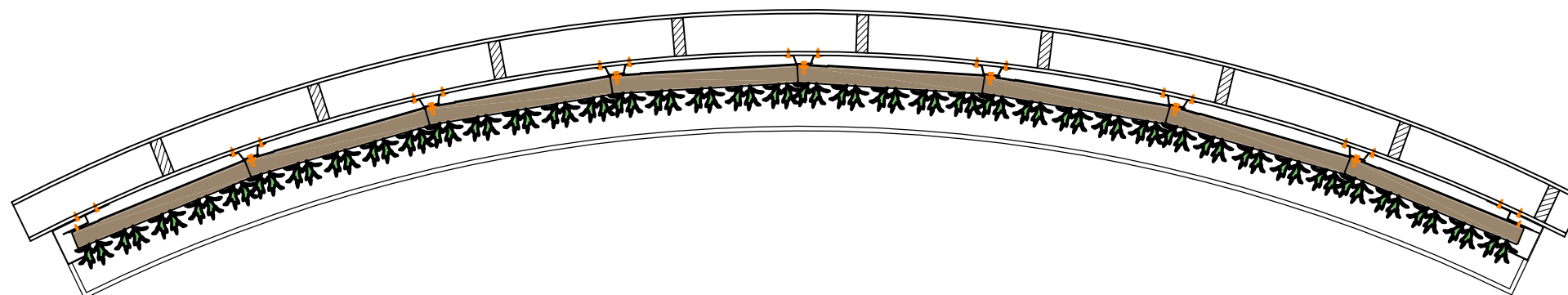
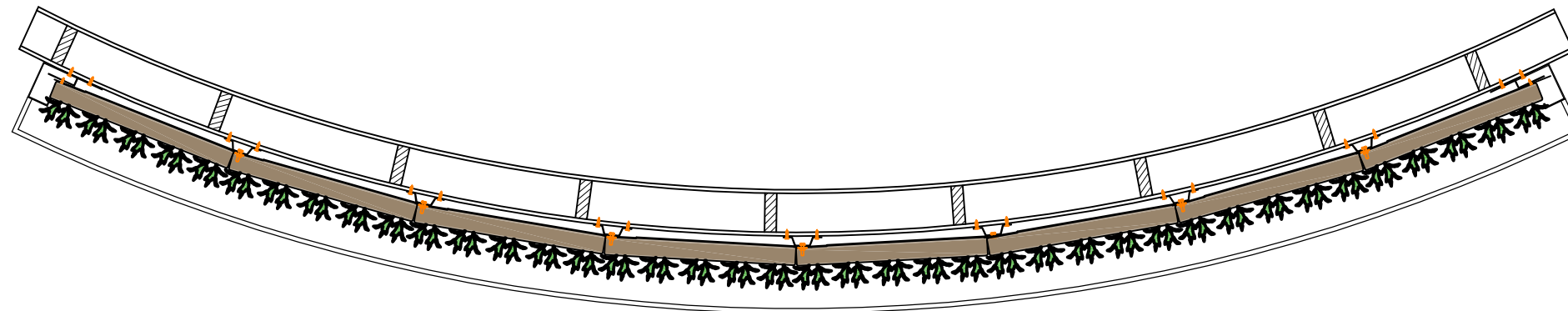

Cradle to Cradle
zertifiziert



Max. gesättigtes
Gewicht

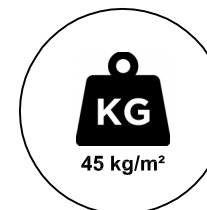

Webbasiertes
Bewässerungssystem



Garantie Flexipanel

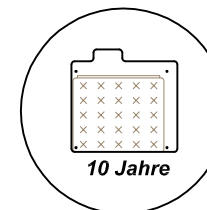

Beschreibung
SemperGreenwall
Indoor gebogene wand

Maßstab
1:20

Format
A3

Datum
25.01.2021

Zeichnung Nr.
SGWI-H04